



Read this document carefully before using this device. The guarantee will be expired by damaging of the device if you don't attend to the directions in the user manual. Also we don't accept any compensations for personal injury, material damage or capital disadvantages.

ENDA ET2011 PID TEMPERATURE CONTROLLER

Thank you for choosing ENDA ET2011 temperature controller.

- * 77 x 35mm sized.
- * Selectable dual-set value.
- * Selectable thermocouple types or Pt100 input.(Selection must be specified in order).
- * Automatic calculation of PID parameters.(SELF TUNE).
 Enter PID parameters of the system if they are known at the beginning. Otherwise, Self-Tune should be activated.
- * Soft-Start feature.
- * Input offset feature.
- * C/A2 Relay output can be programmable as alarm or control output.
- * Selectable SSR control output.
- * Selectable heating/cooling control.
- * In the case of sensor failure periodical running or relay state can be selected.
- * CE marked according to European Norms.



RoHS
Compliant

TECHNICAL SPECIFICATIONS

Input type	Temperature range		Accuracy
	°C	°F	
Pt 100 Resistance thermometer EN 60751	-99.9...300.0 °C	-99.9...543.0 °F	± 0,5% (of full scale) ± 1 digit
Pt 100 Resistance thermometer EN 60751	-200...600 °C	-328...1112 °F	± 0,5% (of full scale) ± 1 digit
J (Fe-CuNi) Thermocouple EN 60584	0... 600°C	+32... +1112°F	± 0,5% (of full scale) ± 1 digit
K (NiCr-Ni) Thermocouple EN 60584	0...1300°C	+32... +2372°F	± 0,5% (of full scale) ± 1 digit
T (Cu-CuNi) Thermocouple EN 60584	0... 400°C	+32... +752°F	± 0,5% (of full scale) ± 1 digit
S (Pt10Rh-Pt) Thermocouple EN 60584	0...1700°C	+32... +3092°F	± 0,5% (of full scale) ± 1 digit
R (Pt13Rh-Pt) Thermocouple EN 60584	0...1700°C	+32... +3092°F	± 0,5% (of full scale) ± 1 digit

ENVIRONMENTAL CONDITIONS

Ambient/storage temperature	0 ... +50°C/-25... +70°C (with no icing)		
Max. Relative humidity	80% up to 31°C decreasing linearly 50% at 40.		
Rated pollution degree	According to EN 60529	Front panel :	IP65
		Rear panel :	IP20
Height	Max. 2000m		



Do not use the device in locations subject to corrosive and flammable gases.

ELECTRICAL CHARACTERISTICS

Supply	230V AC +%/10 -%/20, 50/60Hz or 24V AC %±10, 50/60Hz
Power consumption	Max. 5VA
Wiring	Power connector: 2.5mm ² screw-terminal, Signal connector: 1,5mm ² screw-terminal connection.
Line resistance	Max. 100ohm
Data retention	EEPROM (minimum 10 years)
EMC	EN 61326-1: 2006
Safety requirements	EN 61010-1: 2010 (Pollution degree 2, overvoltage category II)

OUTPUTS

C/A2 output	Rôle : 250V AC, 8A (for resistive load), Selectable as NO+NC Control or Alarm2 output. Rôle : 250V AC, 16A (for resistive load), Selectable as NO Control or Alarm2 output.
SSR output	Max 20mA 12Volt (as control output)
Life expectancy for relay	Without load 30.000.000 mechanical operation; 250V AC, on the 8A resistive load 100.000 electrical switching

CONTROL

Control type	Single set-point and alarm control
Control algorithm	On-Off / P, PI, PD, PID (selectable)
A/D converter	12 bit
Sampling time	100ms
Proportional band	Adjustable between 0% and 100%. If Pb=0%, On-Off control is selected.
Control period	Adjustable between 1 and 250 seconds
Hysteresis	Adjustable between 1 and 50°C/F
Output power	The ratio of power at a set point can be adjusted between 0% and 100%

HOUSING

Housing type	Suitable for flush-panel mounting according to DIN 43 700.
Dimensions	W77xH35xD71mm
Weight	Approx. 200g (after packing)
Enclosure material	Self extinguishing plastics.



While cleaning the device, solvents (thinner, benzine, acid etc.) or corrosive materials must not be used.

Entering from the programming mode to the run mode:

If no key is pressed within 20 seconds during programming mode, the data is stored automatically and the run mode is entered.

Alternatively, the same function occurs first pressing \blacktriangle key and \blacktriangledown key is pressing programming mode is entered. Then \blacksquare and \blacktriangle keys are pressing together, data is recorded and running mode is entered.

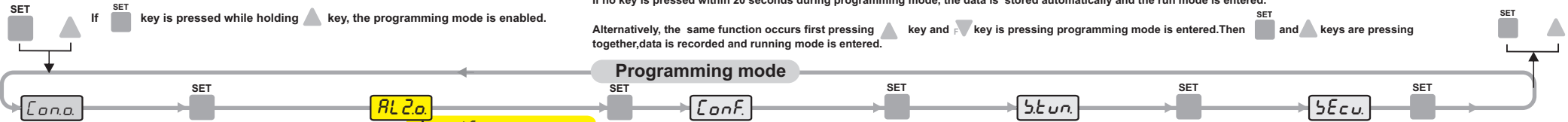

Cono. Control output selection.
AL2.o. Alarm2 set value lower limit. Adjustable between 0 and **AL2.H** parameter value.
AL2.H Alarm2 set value upper limit. Adjustable between **AL2.L** parameter value and upper scale value.
AL2.HY Hysteresis of the Alarm2 output. Adjustable between 1 and 50 °C.
AL2.P Function of Alarm2 type. Four kinds of functions can be selected.
AL2.E The state of Alarm2 output.
AL2.Er State of Alarm2 output in the case of sensor failure.
inPt Input type selection.
FEcn = J type, **ncnR** = K type, **ccn** = T type, **P10r** = S type, **P13r** = R type thermocouple selection.
Unit The temperature unit.
FLtr Coefficient of digital filter.
CoSE Control output selection.
oFFs Offset value.
FFEC Function key setting parameter.
nsEt The percentage of manual output parameter.
Setcu. Self tune control parameter.
Setcod. Security menu access code.
Setcsc. Parameters of **Cono.** menu security access level code.
Setpsc. Parameters of **Setun.** menu security access level code.
SetdEP. Parameters of **ConF.** menu security access level code.
C.SLo Control set point lower limit. (for selected output). Adjustable between 0 and **C.SHi**.
C.SHi Control setpoint upper limit. (for selected output). Adjustable between **C.SLo** and Upper scale value.
C.Pb Proportional band. (for selected output). Adjustable between %0.0 and %100.0.
CHYS Hysteresis of the output. (for selected output). Adjustable between 1 and 50 °C.
CEt Integral time. (for selected output). Adjustable between 0.00 and 100.0 minutes.
CEd Derivative time. (for selected output). Adjustable between 0.00 and 25.00 minutes.
CEt = Period time. (for selected output). Adjustable between 1 and 250 second.
CEPSt The ratio of output power at the setpoint. Adjustable between %0 and %100.
CEPs The percentage of faulty sensor selected output power. Adjustable between %0 and %100.
SetSt Sofy starter timer set value.
CEYP Control output type.

If **CoSE** parameter is different from C-A2, this parameter is seen.
CoSE = C-A2= C/A2 (Relay) output selection, SSR= SSR output selection
oFFs = Offset value. Offset value is added to the measurement value. Adjusted between -100 and +100°C. The normal value is 0.
FFEC = Function key setting parameter.
nsEt = The percentage of manual output parameter. Adjustable between %0 and %100. This parameter allows manual adjustment of the output power when the manual output selection.
Setcu. Self tune begins when the measurement, **PIdt** message and measurement value are shown alternately. Self tune process completed automatically after the **Setcu** parameter is done no and is entered to the working mode. Self tune process begin when the measured temperature is expected fall below 90% of the set value the display shows **EPH** message alternately. Expected to fall below the temperature set point 60% evolved and then self tune process starts automatically. If asked to abort the self tune process, **Setcu** parameter is done no and \blacktriangledown key is pressed.
Setcod. Security menu access code. It should be 2011.
Setcsc. Parameters of **Cono.** menu security access level code.
Setpsc. Parameters of **Setun.** menu security access level code.
SetdEP. Parameters of **ConF.** menu security access level code.

C.SLo = Control set point lower limit. (for selected output). Adjustable between 0 and **C.SHi**.
C.SHi = Control setpoint upper limit. (for selected output). Adjustable between **C.SLo** and Upper scale value.
C.Pb = Proportional band. (for selected output). Adjustable between %0.0 and %100.0. **C.Pb** = %0.0, On-Off control is selected.
CHYS = Hysteresis of the output. (for selected output). Adjustable between 1 and 50 °C. \blacktriangle **C.Pb** = 0, this parameter is active.
CEt = Integral time. (for selected output). Adjustable between 0.00 and 100.0 minutes. \blacktriangle **C.Pb** parameter is different from "0", this parameter appears.
CEd = Derivative time. (for selected output). Adjustable between 0.00 and 25.00 minutes. \blacktriangle **C.Pb** parameter is different from "0", this parameter appears.
CEt = Period time. (for selected output). Adjustable between 1 and 250 second. \blacktriangle **C.Pb** parameter is different from "0", this parameter appears.
CEPSt = The ratio of output power at the setpoint. Adjustable between %0 and %100.
CEPs = The percentage of faulty sensor selected output power. Adjustable between %0 and %100.
SetSt = Sofy starter timer set value. This parameter indicates the time to reach set point value when the device is first enegised. Adjustable between 0 and 250 minutes. If 0 is selected, soft start feature will be enable and the device reaches set point value quickly. \blacktriangle Setting **Pb** = 0, soft start feature will be disable.
CEYP = Control output type. **CEYP** = HEAt means heatign control. **CEYP** = COol means cooling control.

inPt = Input type selection. **FEcn** = J type, **ncnR** = K type, **ccn** = T type, **P10r** = S type, **P13r** = R type thermocouple selection. \blacktriangle This parameter varies when changing some parameters.
Unit = The temperature unit. **oF** = °C, **oF** = °F. \blacktriangle (This parameter varies when changing some parameters.)
FLtr = Coefficient of digital filter. Filter for display value. Adjustable between 1 and 200. If this parameter is 1, digital filter runs most quick. If the parameter is 200, the filter run most slow. The value of parameter should be increased in interference.
CoSE = Control output selection. C-A2= C/A2 (Relay) output selection, SSR= SSR output selection
oFFs = Offset value. Offset value is added to the measurement value. Adjusted between -100 and +100°C. The normal value is 0.
FFEC = Function key setting parameter. **nonE** = Function key is off. **CEsR** = The function key with 2.set value is used. **nAnu** = Manual mode can be achieved with the function key. **dsPo** = Only the temperature display mode is entered with function key.
nsEt = The percentage of manual output parameter. Adjustable between %0 and %100. This parameter allows manual adjustment of the output power when the manual output selection. \blacktriangle **C.Pb** = 0, this parameter is not seen.

Setcu. Self tune control parameter. If both \blacksquare and \blacktriangle keys are pressed, **Setcu** message is displayed on the screen and self tune process is started automatically. If both \blacksquare and \blacktriangledown keys are pressed, no message is displayed on the screen and self tune process is stopped. Self tune begins when the measurement, **PIdt** message and measurement value are shown alternately. Self tune process completed automatically after the **Setcu** parameter is done no and is entered to the working mode. Self tune process begin when the measured temperature is expected fall below 90% of the set value the display shows **EPH** message alternately. Expected to fall below the temperature set point 60% evolved and then self tune process starts automatically. If asked to abort the self tune process, **Setcu** parameter is done no and \blacktriangledown key is pressed.
Setcod. Security menu access code. It should be 2011.
Setcsc. Parameters of **Cono.** menu security access level code. **nonE** = Invisible. **PYE5** = Modification can be done. **Pno** = Only visible. **Setcsc.** Parameters of **AL2.o.** menu security access level code. **nonE** = Invisible. **PYE5** = Modification can be done. **Pno** = Only visible.
Setpsc. Parameters of **Setun.** menu security access level code. **nonE** = Invisible. **PYE5** = Modification can be done. **Pno** = Only visible.
SetdEP. Parameters of **ConF.** menu security access level code. **no** = Parameter settings are not change. **YE5** = Parameter setting will be restored.

\blacktriangle While the parameter names appear, if \blacktriangle and \blacktriangledown keys are pressed together, returns to the program mode.

DEFAULT PARAMETERS													
Set parameters	Control output parameters		Alarm2 output parameters		Configuration parameters			Self tune parameters		Security parameters			
	TC input	Pt100 input	TC input	Pt100 input	TC input	Pt100 input	TC input	Pt100 input	TC input	Pt100 input			
C.SLo 400	C.SLo	0	-200	AL2.L 0	AL2.H 600	inPt	FEcn	oF	Setcu.	Setcod.	PYE5		
C.SHi 400	C.SHi	600		AL2.H 600		Unit	FLtr	25	Setcu.	Setcsc.	PYE5		
AL2.E 500	C.Pb	0		AL2.HY 2		CoSE	CE-R2	0	Setcu.	Setpsc.	PYE5		
	CHYS	2		AL2.P	indE	oFFs	nonE	0	Setcu.	dEP.	no		
	CEt	4.0		AL2.E	H	FFEC	nonE						
	CEd	1.00		AL2.Er	on	nsEt	nonE	50					
	CEt	20											
	CEPSt	0											
	CEPs	0											
	SetSt	0											
	CEYP	HEAt											

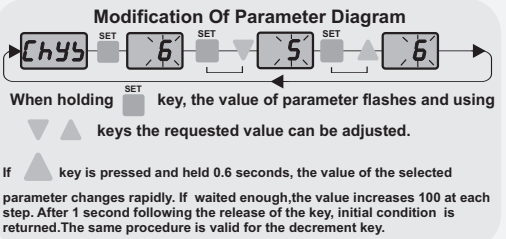

TERMS

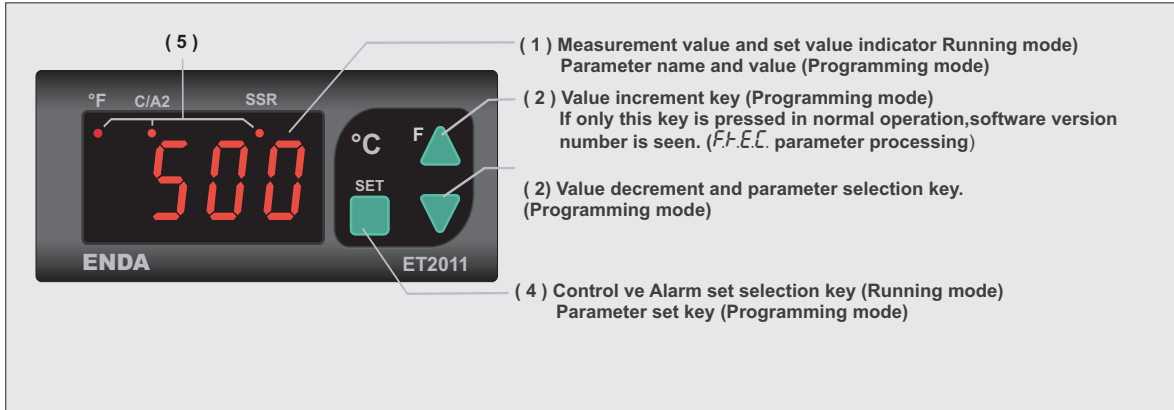

(1) PV and SV display	7 segment, 4 digits red LED display
Character heights	12 mm
(2),(3),(4) Keypad	Mikro switch
(5) State indicator	For control, Alarm1 and SSR outputs 3 digits red LED

ALARM2 OUTPUT TYPES

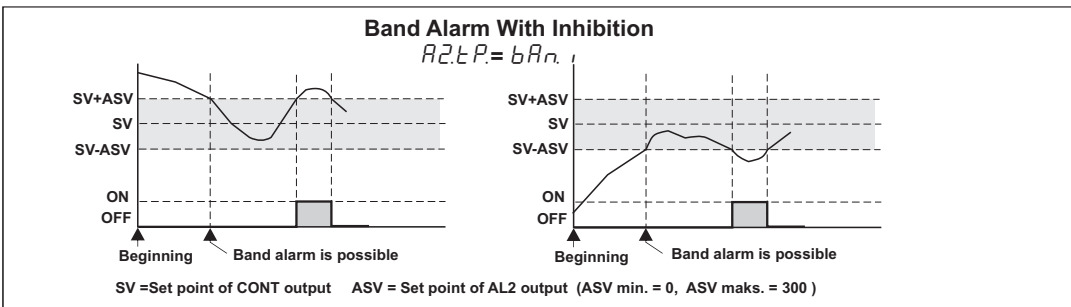
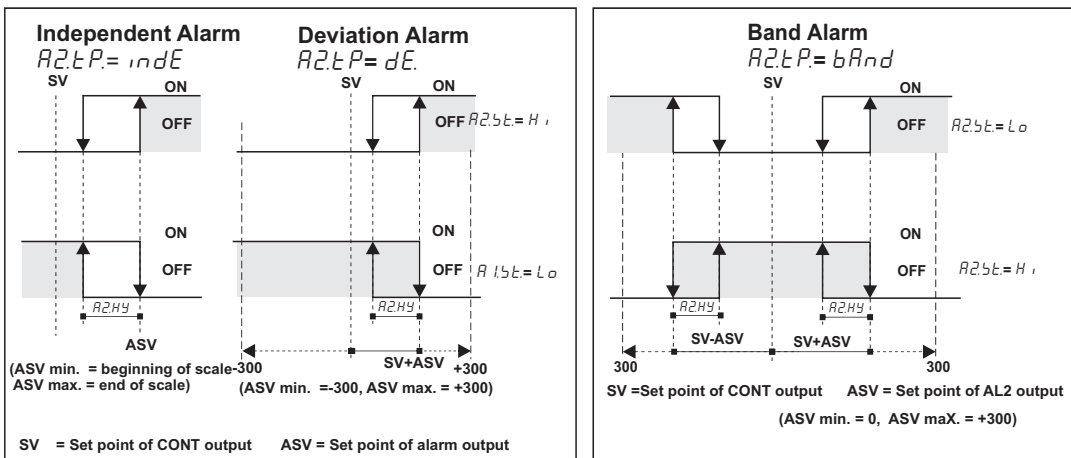

MODIFICATION OF CONTROL AND ALARM SET POINTS

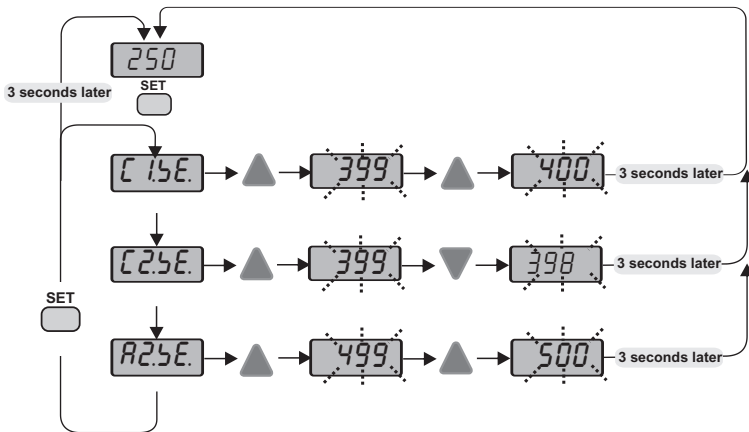

ERROR MESSAGES

- PFR Sensor is broken
- Temperature value is higher than the value
- Temperature value is lower than the scale
- P5C Pt100 sensor is short circuit

F.F.E.C. parameter, is set to the C25E parameter, this parameter is displayed.

C25E parameter is set to the output of SSR, this parameter is seen.

DIMENSIONS



For removing the device from the panel:
- While pressing both side of the device in direction 1, push it in direction 2.

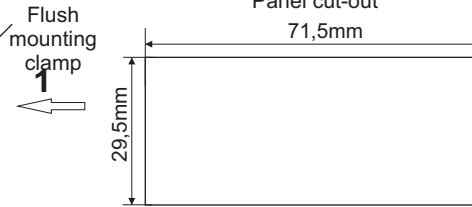
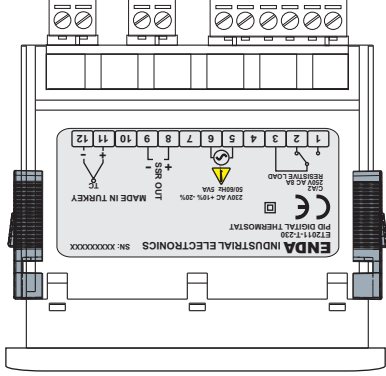
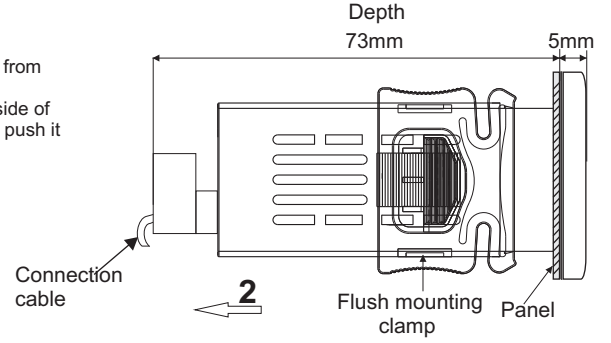

Note

- 1) Panel thickness should be maximum 7mm.
- 2) If there is no 60mm free space at back side of the device, it would be difficult to remove it from the panel.

Order Code: ET2011-X-XXX-X

Input selection
RT.....PT100 input
T.....TC input

Supply voltage
230VAC.....230V AC
110VAC.....110V AC
024VAC.....24V AC
SM.....9-30VDC/7-24V AC

Contact current selection
None.....8A contact output
P.....16A contact output

CONNECTION DIAGRAM



ENDA ET2011 is intended for installation in control panels. Make sure that the device is used only for intended purpose. The shielding must be grounded on the instrument side. During an installation, all of the cables that are connected to the device must be free of energy. The device must be protected against inadmissible humidity, vibrations, severe soiling. Make sure that the operation temperature is not exceeded. All input and output lines that are not connected to the supply network must be laid out as shielded and twisted cables. These cables should not be close to the power cables or components. The installation and electrical connections must be carried on by a qualified staff and must be according to the relevant locally applicable regulations.

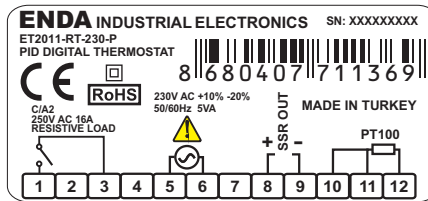
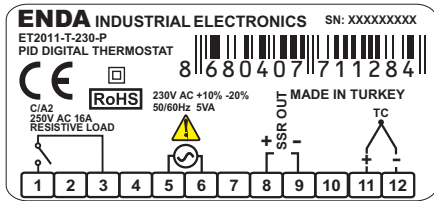
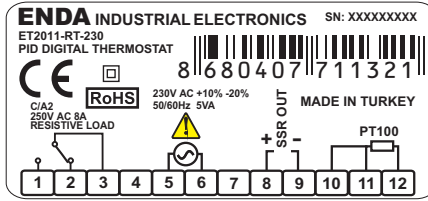
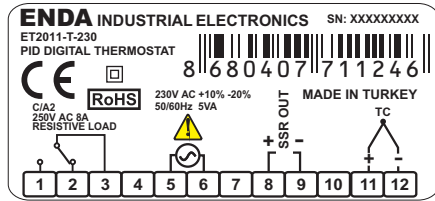

Holding screw
0.4-0.5Nm

Equipment is protected throughout
by DOUBLE INSULATION.

NOTE :

SUPPLY:



Note 1) Mains supply cords shall meet the requirements of IEC 60227 or IEC 60245.
2) In accordance with the safety regulations, the power supply switch shall bring the identification of the relevant instrument and it should be easily accessible by the operator.